



2027 Competition Format: Age Group 2017 B

40 Teams | 8 Groups of 5 | Category B and Category C Knock Out Structure

Group Stage

Group A	Group B	Group C	Group D
• A1	• B1	• C1	• D1
• A2	• B2	• C2	• D2
• A3	• B3	• C3	• D3
• A4	• B4	• C4	• D4
• A5	• B5	• C5	• D5
Group E	Group F	Group G	Group H
• E1	• F1	• G1	• H1
• E2	• F2	• G2	• H2
• E3	• F3	• G3	• H3
• E4	• F4	• G4	• H4
• E5	• F5	• G5	• H5

Each team plays **4 group matches**. After the group stage, teams are ranked **1st to 5th** in each group.

Progression Overview

Category B Knock Outs

The **1st and 2nd placed teams** from each group qualify directly to the **Stage of 16**, called **Category B Knock Outs**.

This is a **separate competition bracket**, which determines the final ranking within **Category B from 1st to 16th**.

Category C Knock Outs

All **3rd placed teams** from each group qualify directly to **Category C Knock Outs**.

The **4th and 5th placed teams** from each group enter **play off games** to determine the additional **8 teams** that will qualify for the **Category C Quarterfinals**.

This is a **separate competition bracket**, which determines the final ranking within **Category C from 1st to 16th**.

GROUP A	GROUP B	GROUP C	GROUP D	GROUP E	GROUP F	GROUP G	GROUP H
1st (A1)	1st (B1)	1st (C1)	1st (D1)	1st (E1)	1st (F1)	1st (G1)	1st (H1)
2nd (A2)	2nd (B2)	2nd (C2)	2nd (D2)	2nd (E2)	2nd (F2)	2nd (G2)	2nd (H2)
3rd (A3)	3rd (B3)	3rd (C3)	3rd (D3)	3rd (E3)	3rd (F3)	3rd (G3)	3rd (H3)
4th (A4)	4th (B4)	4th (C4)	4th (D4)	4th (E4)	4th (F4)	4th (G4)	4th (H4)
5th (A5)	5th (B5)	5th (C5)	5th (D5)	5th (E5)	5th (F5)	5th (G5)	5th (H5)

CATEGORY B KNOCK OUTS (Category B places 1–16)

Stage of 16

- B-R16-1: A1 vs B2
- B-R16-2: B1 vs A2
- B-R16-3: C1 vs D2
- B-R16-4: D1 vs C2
- B-R16-5: E1 vs F2
- B-R16-6: F1 vs E2
- B-R16-7: G1 vs H2
- B-R16-8: H1 vs G2

Winners -> Category B Quarterfinals
 Losers -> Category B 9th–16th Classification

CATEGORY C QUALIFICATION

Directly qualified teams:
 A3, B3, C3, D3, E3, F3, G3, H3

Play Offs between 4th and 5th placed teams:

- P01: A4 vs B5
- P02: B4 vs A5
- P03: C4 vs D5
- P04: D4 vs C5
- P05: E4 vs F5
- P06: F4 vs E5
- P07: G4 vs H5
- P08: H4 vs G5

Winners -> Category C Quarterfinals
 Losers -> eliminated from further competition unless you later add a separate lower classification bracket

CATEGORY C KNOCK OUTS (Category C places 1–16)

Quarterfinals

- C-QF1: A3 vs Winner P03
- C-QF2: B3 vs Winner P04
- C-QF3: C3 vs Winner P01
- C-QF4: D3 vs Winner P02
- C-QF5: E3 vs Winner P07
- C-QF6: F3 vs Winner P08
- C-QF7: G3 vs Winner P05
- C-QF8: H3 vs Winner P06

Winners -> Category C Semifinal route for places 1–8
 Losers -> Category C 9th–16th Classification

Category B – Main Bracket

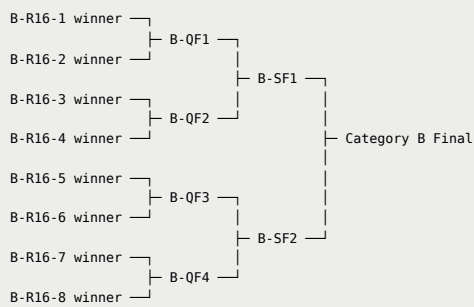

Category B – 9th–16th Classification

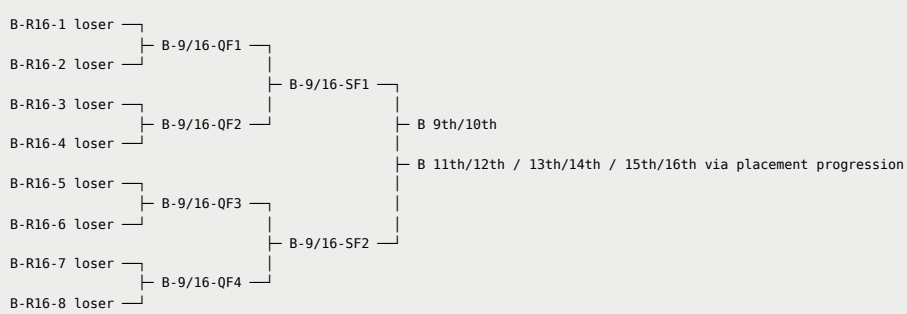

Category C – Qualification and Main Bracket

Category C Play Offs

- P01: A4 vs B5
- P02: B4 vs A5
- P03: C4 vs D5
- P04: D4 vs C5
- P05: E4 vs F5
- P06: F4 vs E5
- P07: G4 vs H5
- P08: H4 vs G5

Category C Quarterfinal Entry

- A3 vs Winner P03
- B3 vs Winner P04
- C3 vs Winner P01
- D3 vs Winner P02
- E3 vs Winner P07
- F3 vs Winner P08
- G3 vs Winner P05
- H3 vs Winner P06

Category C – Main Bracket

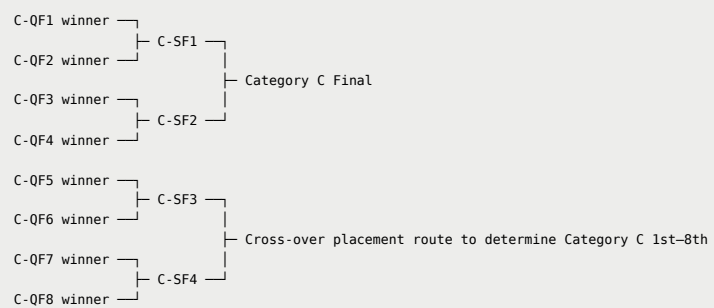

Match Progression By Finishing Position

If a team finishes 1st–2nd in its group

Path:

- 4 group matches
- Category B Round of 16
- Category B quarterfinal or Category B 9th–16th quarterfinal
- semifinal
- final placement match

Total:

- **8 matches**

If a team finishes 3rd in its group

Path:

- 4 group matches
- Category C first knock out match
- Category C quarterfinal or Category C 9th–16th quarterfinal
- semifinal
- final placement match

Total:

- **8 matches**

If a team finishes 4th–5th in its group and wins the play off

Path:

- 4 group matches
- Category C play off
- Category C first knock out match
- semifinal or placement semifinal
- final placement match

Total:

- **8 matches**

If a team finishes 4th–5th in its group and loses the play off

Path:

- 4 group matches
- play off only

Total:

- **5 matches**

Final Ranking Structure

Category B Final Ranking

Category B 1st -> Category B Final winner
 Category B 2nd -> Category B Final loser
 Category B 3rd -> Category B 3rd/4th winner
 Category B 4th -> Category B 3rd/4th loser
 Category B 5th -> Category B 5th/6th winner
 Category B 6th -> Category B 5th/6th loser
 Category B 7th -> Category B 7th/8th winner
 Category B 8th -> Category B 7th/8th loser
 Category B 9th -> Category B 9th/10th winner
 Category B 10th -> Category B 9th/10th loser
 Category B 11th -> Category B 11th/12th winner
 Category B 12th -> Category B 11th/12th loser
 Category B 13th -> Category B 13th/14th winner
 Category B 14th -> Category B 13th/14th loser
 Category B 15th -> Category B 15th/16th winner
 Category B 16th -> Category B 15th/16th loser

Category C Final Ranking

Category C 1st -> Category C Final winner
 Category C 2nd -> Category C Final loser
 Category C 3rd -> Category C 3rd/4th winner
 Category C 4th -> Category C 3rd/4th loser
 Category C 5th -> Category C 5th/6th winner
 Category C 6th -> Category C 5th/6th loser
 Category C 7th -> Category C 7th/8th winner
 Category C 8th -> Category C 7th/8th loser
 Category C 9th -> Category C 9th/10th winner
 Category C 10th -> Category C 9th/10th loser
 Category C 11th -> Category C 11th/12th winner
 Category C 12th -> Category C 11th/12th loser
 Category C 13th -> Category C 13th/14th winner
 Category C 14th -> Category C 13th/14th loser
 Category C 15th -> Category C 15th/16th winner
 Category C 16th -> Category C 15th/16th loser

Short Overview

2017 B Competition Format

- 40 teams divided into 8 groups of 5
- Each team plays all other teams in its group once
- The 1st and 2nd placed teams from each group qualify directly to the Stage of 16, named **Category B Knock Outs**
- Category B is a separate knock out and classification bracket determining final positions **1st to 16th within Category B**
- All 3rd placed teams qualify directly to **Category C Knock Outs**
- The 4th and 5th placed teams enter play off matches to determine the additional 8 teams that will join Category C
- Category C is a separate knock out and classification bracket determining final positions **1st to 16th within Category C**
- Pairings are arranged so that teams do not face teams from the same group at the first knock out stage where possible
- Losing teams continue through placement matches in both categories so that all final ranking positions are determined within each category

One important note: as written, the **4th/5th teams that lose the play off do not continue**, so they do **not** get a separate ranking